



## Combination air valve with rapid filling preventer mechanism Mod. GOLIA 3F - RFP

The CSA air valve Mod. FOX GOLIA 3F RFP will ensure the proper operation of the system allowing the air release during working conditions, and the entrance of large volumes of air during draining. In addition to that this model will always control the air outflow within a safety limit, without the risk of water hammer.



### Technical features and benefits

- Uncontrolled pipeline filling operations and transient events will inevitably generate the rapid closure of the air valves install along the system, with consequent damages. The CSA air valve GOLIA 3F RFP will automatically adjust the outflow capacity, thus reducing the velocity of the incoming water column minimizing the risk of water hammer.
- The spray effect during closure and the risk of air valve drowning, due to low pressure and possible rapid filling, is avoided.
- Entirely made in high resistant materials suitable for industrial and aggressive environments.
- Mobile block composed of a cylindrical float and obturator, joined together by the CSA air release system (pat. Pending), along with the upper disk all made in solid polypropylene. The solid cylindrical floats, obtained by CNC machining, avoid deformations and ensure a great sliding precision.
- Nozzle and gasket holder, part of CSA air release system, entirely made in AISI 316/Super Duplex and designed with gasket compression control to prevent aging process and consequent leakage during working conditions.

### Applications

- Seawater main transmission lines.
- Desalination plants.
- Demineralized water.
- Mines.
- Aggressive and corrosive fluid, and more in general whenever ductile cast iron is not accepted.

## Operating principle



### Discharge of large volumes of air

During the pipe filling it is necessary to discharge air as water flows in. The Golia 3F RFP, thanks to an aerodynamic full port body and deflector, will make sure to avoid premature closures of the mobile block during this phase.

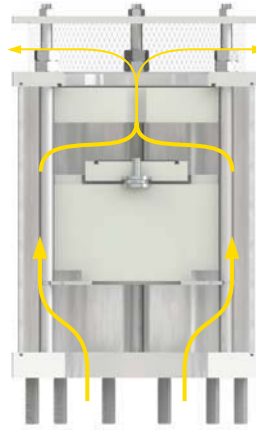

### Controlled outflow

If the differential pressure of air, during pipe filling, increases above a certain value without control there is the risk of water hammer and damages to the system. Should that happen the RFP upper float will rise automatically, reducing the outflow and consequently the velocity of the approaching water column.



### Air release during working conditions

During operation the air produced by the pipeline is accumulated in the upper part of the air valve. Little by little it is compressed and the pressure arrives to water pressure, therefore its volume increases pushing the water level downwards allowing the air release through the nozzle.

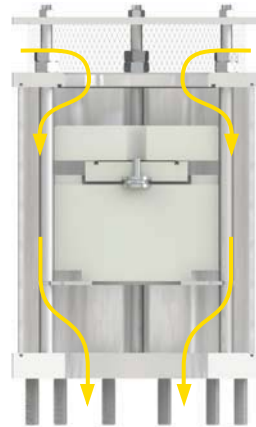

### Entrance of large volumes of air

During pipeline draining, or pipe bursts, it is necessary to bring in as much air as the quantity of outflowing water to avoid negative pressure and serious damages of the pipeline, and to the entire system.

## Optional



■ **Vacuum breaker version Mod. Golia 2F RFP**, to allow the entrance of large volumes of air and the controlled outflow only. This model is normally recommended in changes in slope ascending, long ascending segments, dry fire systems, and wherever the water hammer effect has to be reduced without the necessity of air release.



■ **Version for submerged applications, SUB series**, available both for Golia 3F RFP and 2F RFP Models, with elbow for air conveyance. The design sprang from the necessity of having an air valve performing also in case of flood, without the risk of contaminated water entering the pipeline. Another benefit of SUB is to avoid the spray effect, conveying spurts coming from the closure away from the air valve.



■ **Version for air discharge only EO series**, available both for Golia 3F RFP and 2F RFP models. The most important application of EO is to allow the air valve installation in those locations of the system where HGL may drop below the pipe profile, and to any other node where for project requirements air entrance must be avoided.

## Air flow performance charts

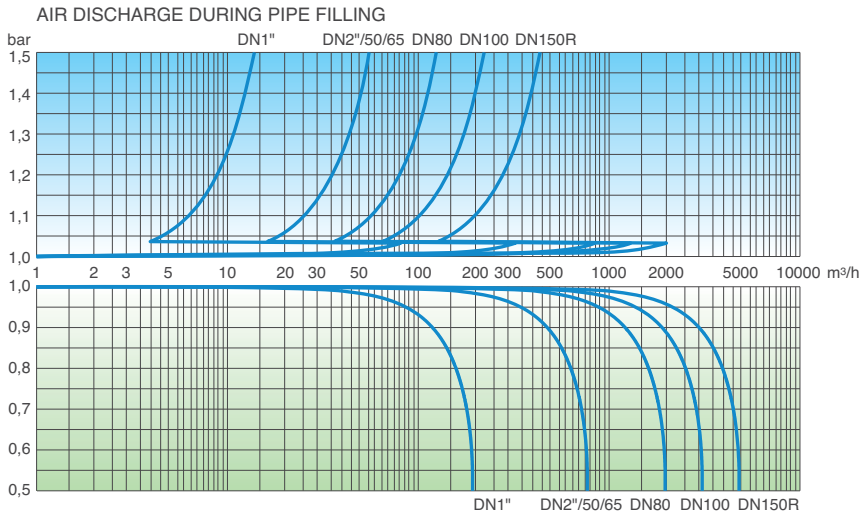

The air flow charts were created in Kg/s from laboratory tests and numerical analysis, then converted using a safety factor.

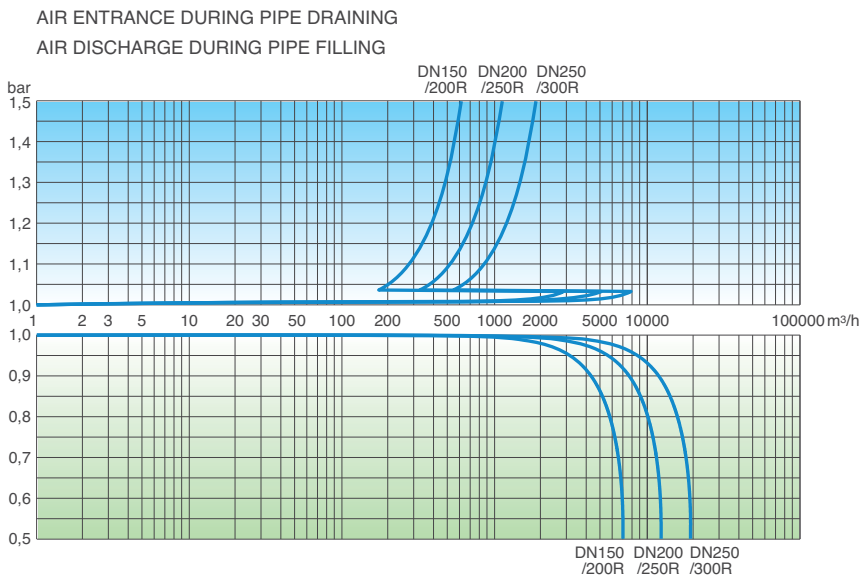
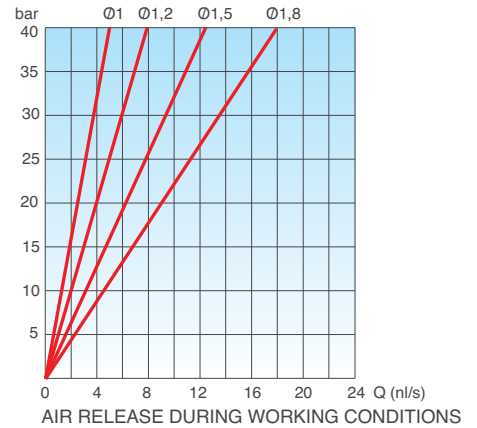

AIR ENTRANCE DURING PIPE DRAINING

### Working conditions

Treated water max. 70°C;  
Max. pressure 40 bar;  
Min. pressure 0,2 bar;  
PN16 version to 0,19 bar and  
solutions for high temperatures on request.

### Standard

Designed in compliance with AS4956.  
Flanges according to AS4087 PN16/35 and ANSI.  
Gaskets in NBR / EPDM / Viton.  
Changes and variations on the flanges and gaskets are available on request.

| CONNECTION<br>inch/mm | A<br>mm | B<br>mm | C<br>mm | Weight<br>Kg |
|-----------------------|---------|---------|---------|--------------|
| Threaded 1"           | 165     | 240     | =       | 6,4          |
| Threaded 2"           | 165     | 240     | =       | 6,4          |
| Flanged 50            | 165     | 240     | 40      | 8,0          |
| Flanged 65            | 185     | 240     | 40      | 8,0          |
| Flanged 80            | 200     | 265     | 50      | 12,0         |
| Flanged 100           | 235     | 334     | 50      | 17,0         |
| Flanged 150R          | 235     | 235     | 50      | 27,0         |
| Flanged 150           | 300     | 440     | 70      | 45,0         |
| Flanged 200R          | 360     | 440     | 70      | 49,0         |
| Flanged 200           | 360     | 515     | 70      | 62,0         |
| Flanged 250R          | 405     | 515     | 70      | 72,0         |
| Flanged 250           | 405     | 630     | 85      | 125,0        |
| Flanged 300R          | 460     | 635     | 90      | 135,0        |

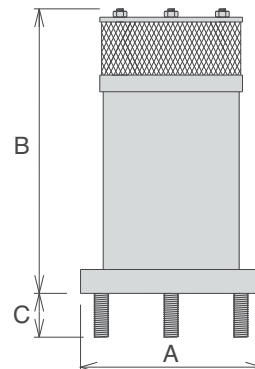

## Technical details

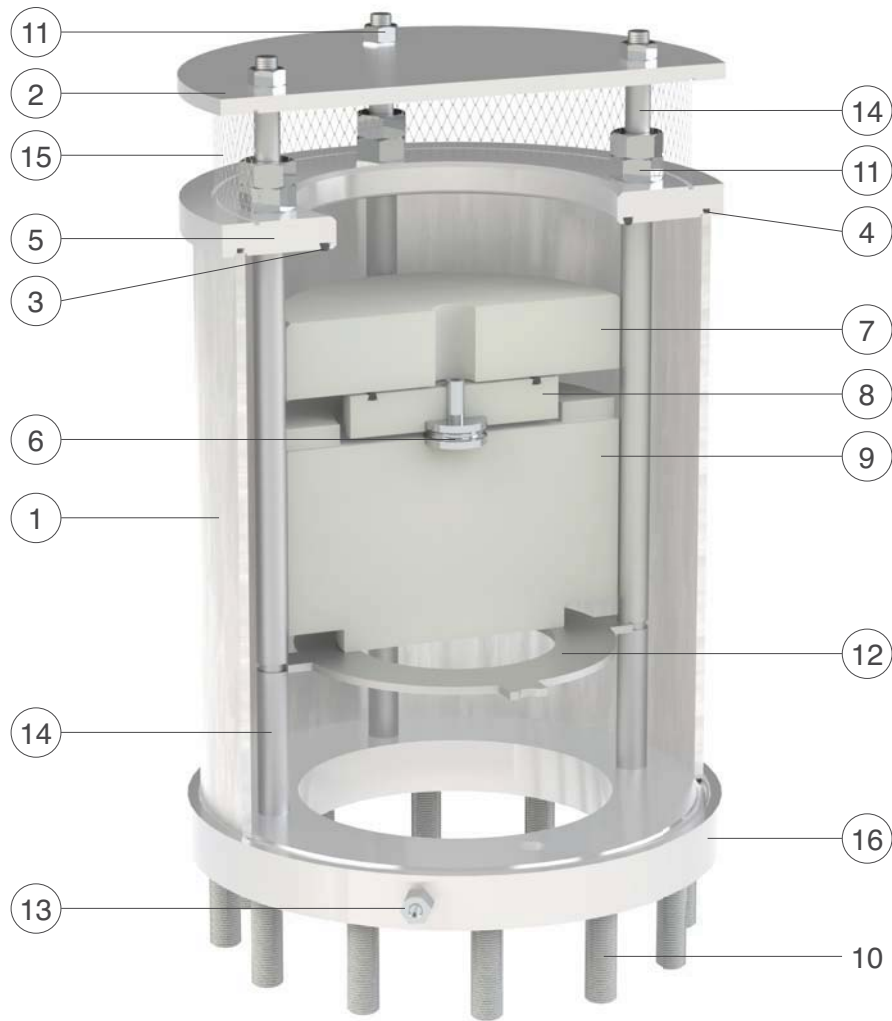

|    | Component     | Standard material        | Optional                 |
|----|---------------|--------------------------|--------------------------|
| 1  | Body          | stainless steel AISI 316 | s.s. Duplex/Super Dupl.  |
| 2  | Cap           | stainless steel AISI 304 | stainless steel AISI 316 |
| 3  | O-ring        | NBR                      | EPDM/Viton/silicone      |
| 4  | O-ring        | NBR                      | EPDM/Viton/silicone      |
| 5  | Seat          | stainless steel AISI 316 | s.s. Duplex/Super Dupl.  |
| 6  | Nozzle Subset | stainless steel AISI 316 | stainless steel Duplex   |
| 7  | RFP flat      | polypropylene            |                          |
| 8  | Upper flat    | polypropylene            |                          |
| 9  | Float         | polypropylene            |                          |
| 10 | Studs         | stainless steel AISI 304 | stainless steel AISI 316 |
| 11 | Bolts         | stainless steel AISI 316 |                          |
| 12 | Diffuser      | stainless steel AISI 316 | s.s. Duplex/Super Dupl.  |
| 13 | Drain valve   | stainless steel AISI 316 |                          |
| 14 | Spacers       | stainless steel AISI 316 | s.s. Duplex/Super Dupl.  |
| 15 | Filter        | stainless steel AISI 304 | stainless steel AISI 316 |
| 16 | Flange        | stainless steel AISI 316 | s.s. Duplex/Super Dupl.  |

The list of materials and components is subject to changes without notice.